



**USER'S MANUAL**  
MANUEL DE L'UTILISATEUR  
MANUAL DEL USUARIO

**DW46F1Y2**

## TABLE OF CONTENTS

1	<b>IMPORTANT INFORMATION</b>		2
2	<b>HOW TO INSTALL THE STAND</b>		4
3	<b>PREFACE</b>		5
4	<b>SAFETY PRECAUTIONS</b>		5
5	<b>CONTENTS</b>		7
6	<b>FRONT/BACK CONNECTIONS OF LCD TV</b>		8
7	<b>TV INSTALLATION</b>	Power Cord Connection	9
		Antenna Connection	9
		AV Connection	10
		YPbPr(component) Connection	10
		VGA(PC)Connection	11
		USB Port Function	11
		HDMI Connection	12
8	<b>REMOTE CONTROL</b>	Remote control instructions in TV mode	13
		Remote control setup	14
9	<b>MENU OPERATION</b>	Setup Wizard	15
		Select Input Source	17
		Basic Operation	17
		Picture Menu	18
		Sound Menu	21
		Time Menu	22
		Setup Menu	23
		Lock Menu	25
		Channel Menu	27
		Setup Menu	29
USB Menu	30		
10	<b>TROUBLESHOOTING</b>		32
11	<b>SPECIFICATIONS</b>		33

## IMPORTANT INFORMATION

---

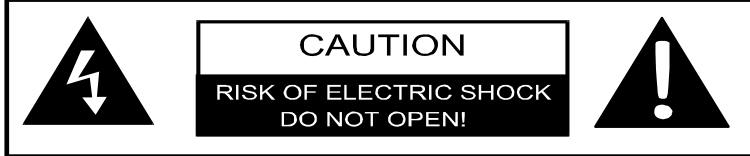

The lightning flash with arrowhead symbol, within an equilateral triangle, is intended to alert the user to the presence of un-insulated dangerous voltage within the products enclosure that may be of sufficient magnitude to constitute a risk of electric to persons.



The exclamation point within an equilateral triangle is intended to alert the user to the presence of important operating and maintenance (servicing) instruction the literature accompanying the appliance.

**CAUTION:** USE OF ANY CONTROLS, ADJUSTMENTS, OR PROCEDURES OTHER THAN THOSE SPECIFIED HEREIN MAY RESULT IN HAZARDOUS RADIATION EXPOSURE.

**CAUTION:** These servicing instructions are for use by qualified service personnel only. To reduce the risk of electric shock, do not perform any servicing other than that contained in the operating instructions unless you are qualified to do so.

Refer to service manual for servicing instructions.

## Important Safety Instructions

### Note:

1. Read these instructions.
2. Keep these instructions.
3. Heed all warnings.
4. Follow all instructions.
5. Do not use near water.
6. Clean only with dry cloth.
7. Do not block any ventilation openings. Install in accordance with the manufacturer's instructions.
8. Do not install near any heat sources such as radiators, heat registers, stoves, or other apparatus (including amplifiers) that produce heat.
9. Do not defeat the safety purpose of the polarized or grounding-type plug. A polarized plug has two blades with one wider than the other. A grounding type plug has two blades and a third grounding prong. The wide blade or the third prong are provided for your safety. If the provided plug does not fit into your outlet, consult an electrician for replacement of the obsolete outlet.

## IMPORTANT INFORMATION

10. Protect the power cord from being walked on or pinched particularly at plugs, convenience receptacles, and the point where they exit from the apparatus.
11. Only use attachments / accessories specified by the manufacturer.
12. Use only with the cart, stand, tripod, bracket, or table specified by the manufacturer, or sold with the apparatus.  
When a cart is used, use caution when moving the cart / apparatus combination to avoid injury from tip-over.



13. Unplug this apparatus during lightning storms or when unused for long periods of time.
14. Refer all servicing to qualified service personnel. Servicing is required when the apparatus has been damaged in any way, such as power-supply cord or plug is damaged, liquid has been spilled or objects have fallen into the apparatus, the apparatus has been exposed to rain or moisture, does not operate normally, or has been dropped.
15. Apparatus shall not be exposed to dripping or splashing and that no objects filled with liquids, such as vases, shall be placed on the apparatus.
16. WARNING: To reduce the risk of fire or electric shock, do not expose this apparatus to rain or moisture.
17. Mains plug or appliance coupler is used as the disconnect device, shall be readily operable.
18. The apparatus shall be connected to a MAINS socket outlet with a protective earthing connection.
19. WARNING: The batteries shall not be exposed to excessive heat such as sunshine, fire or the like.
20. The ON-MODE Power under Home Mode should be less than 74.6W.
21. The Sleep Mode power should be less than 1.0W.
22.  This equipment is a Class II or double insulated electrical appliance. It has been designed in such a way that it does not require a safety connection to electrical earth.

This Westinghouse product has earned the Energy Star® for meeting U.S. Federal energy efficiency guidelines as set by the Department of Energy and Environmental Protection agency. The Energy Star™ program exists to provide energy saving guidelines and help promote energy efficient products and practices. Changes to certain features, settings and functions of this TV can change and/or increase its power consumption. Depending on how settings are changed, power consumption may exceed the limits required for Energy Star® qualification. This Westinghouse TV will operate at optimal energy efficiency in “Home” mode.

### Licensing and Patent Information

This WESTINGHOUSE product may be covered by one or more U.S. and foreign patents and patent applications. See <http://westinghousedigital.com/compliance/> for details.



# How to install the stand!

Follow instructions below to install the base of the TV, reverse the instructions to remove the base.

1. Fix the base cover to the fixed-ring base as image 1;

image 1

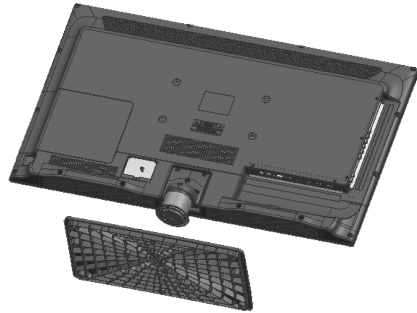

2. Fix the base cover to fixed-ring base with the screws.

image 2

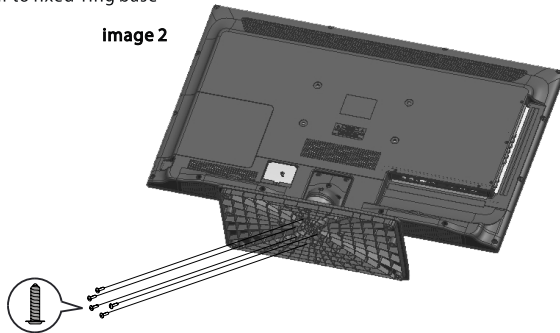

T4x25 5pcs

image 3



### 3. PREFACE

Thank you for buying this TV! Please read this manual thoroughly before operating the TV. Make sure the TV was not damaged in transit. Should the TV be damaged, do not install it and contact your dealer. Check that you have all the accessories according to the model.

### 4. SAFETY PRECAUTIONS



Put the TV on a stable surface.



Do not place any material on the TV.

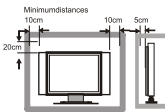

Do not use the TV with fixtures other than those provided or suggested by the manufacturer.



Do not block or cover the ventilation openings on the TV. If you have a wall mount, check that it is steady.



Power cord and cables must be properly routed and protected to prevent people from stepping on them and causing the TV to fall.

## SAFETY PRECAUTIONS

---

English



Keep the TV dry and away from humidity.

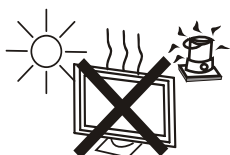

Keep the TV away from heat sources.



Unplug the TV before cleaning it. Do not use solvent or liquid to clean the TV.

Only clean the TV with a soft and dry cloth.

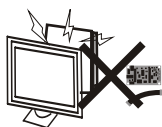

In case of troubleshooting, do not use spare parts other than those suggested by the manufacturer. Using inadequate spare parts can lead to electric shocks, short-circuits, fire or other incidents.



Unplug the TV during lightning storms or when unused for long periods of time.

5. CONTENTS

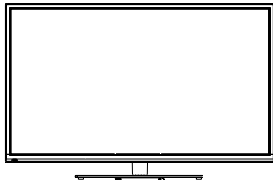

**LED TV SET**



**Remote Control**

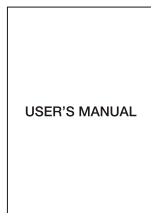

**USER'S MANUAL**

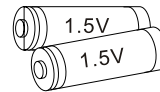

**AAA Batteries**

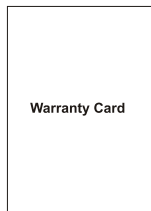

**Warranty Card**

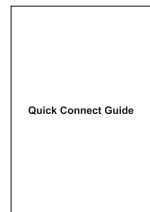

**Quick Connect Guide**

## 6. FRONT/BACK CONNECTIONS OF LED TV

### Front View

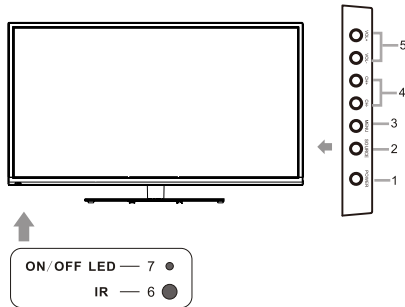

1. Press "POWER" button to turn the TV on or off.
2. Press "SOURCE" to select the input source.
3. Press "MENU" to bring up the main menu on the screen.
4. Press "CH+" or "CH-" to scan through channels.
5. Press "VOL+" or "VOL-" to increase or decrease the volume.
6. REMOTE SENSOR: infrared sensor for the remote control.
7. POWER INDICATOR: Blue when TV is powered on. Red when TV is powered off.

### Back View and Control Connections

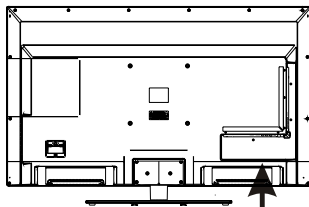

1. Headphone: Connect a stereo headphone for private listening.
2. COAXIAL out: Connect the COAXIAL receiver.
3. L/R: For AUDIO out.
4. AV: Connect the Video and Audio output.
5. YPbPr: Connect the YPbPr and Audio output.
6. HDMI1/HDMI2/HDMI3: Connect the HDMI output jack of DVD.
7. VGA (PC): Connect the PC-RGB output jack of PC. PC AUDIO: Connect the Audio output jack of PC.
8. USB: USB Port.
9. RF IN: Connect the antenna.

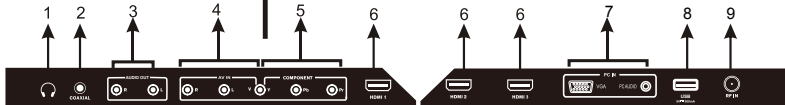

## 7. TV INSTALLATION

### Power Cord Connection

- Connect the power cord correctly as shown.

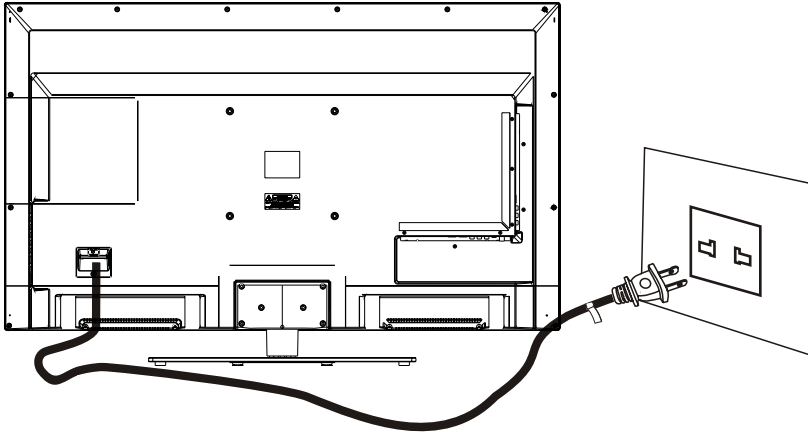

English

### Antenna Connection

To ensure good picture and sound, TV antenna system needs to be installed. The antenna system as shown can be sourced from TV equipment shops, which will provide service for correct installation and connection. After installation, insert the 75-ohm antenna plug into the antenna jack as shown.

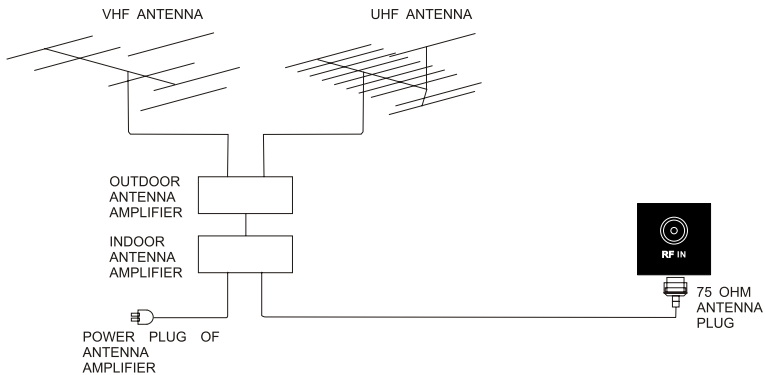

## AV Connection

Connect the VIDEO and AUDIO output jack of the DVD or VCR to the VIDEO jacks on the set using the RCA cable. Match the jack colors: Video is yellow, Audio left is white, and Audio right is red. Select the AV input source using the SOURCE button on the remote control.

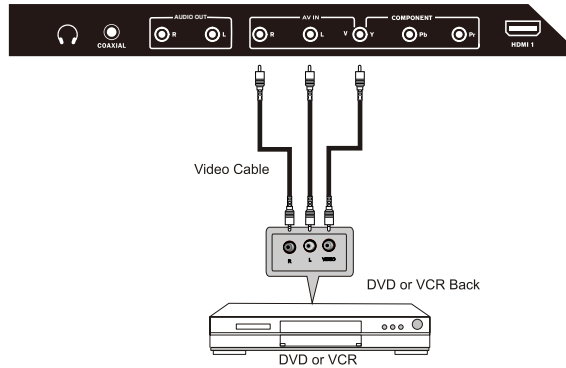

## YPbPr (Component) Connection

Connect the YPbPr output of the DVD or VCR to the YPbPr input on the set. The picture quality is improved; compared to connecting a regular VCR to the video input. Connect the Audio output of the DVD or VCR to the Audio input jacks on the set using the RCA cable. Match the jacks colors :Y is green,Pb is blue,Pr is red,Audio left is white and Audio right is red. Select component input source using the SOURCE button on the remote control.

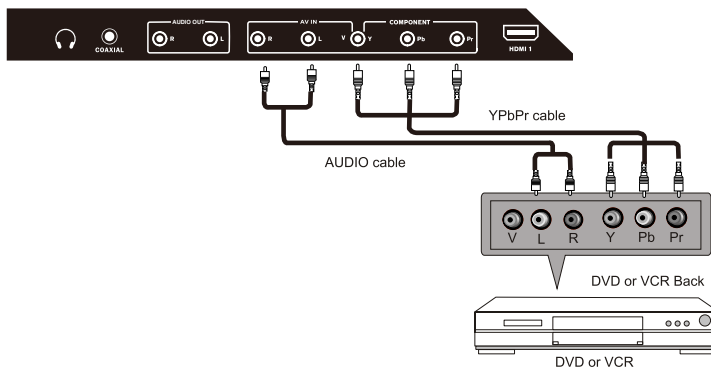

## VGA(PC) Connection

Connect the RGB output of the PC to the VGA(PC) jack on the set. Connect the AUDIO output of The PC to the PC AUDIO jack on the set. Select the VGA input source with using SOURCE button on the remote control.

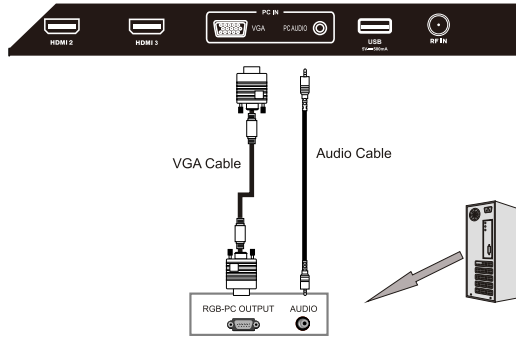

English

## USB Port Function





## HDMI Connection

HDMI plug which replaces the HDMI connection allows transfer of all audio/video control signals through one cable only. These signals are transferred in digital.

English

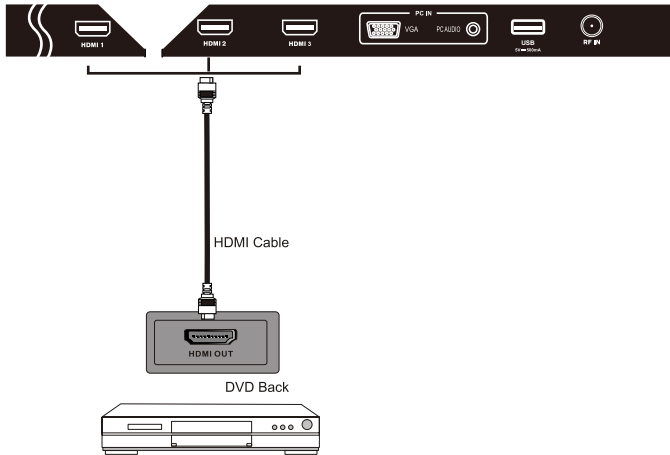

## 8. REMOTE CONTROL

### Remote control instructions in TV mode



**POWER** Turn the LED TV on/off.

**MUTE** Press once to disable the audio and press again to enable the audio.

**NUMBER BUTTONS** Press 0-9 to directly change the TV channel.

— Press this button to enter a program number for multiple program channel such as 2-1, etc.

↶ Return to the previous channel viewed.

**P.MODE** Select the picture mode.

**S.MODE** Select the sound mode.

**MTS** Press to adjust between available audio channel.

**SLEEP** Set the Sleep Timer

**SOURCE** Press Source to display the OSD input source, press ▲ ▼ to select an input source, and then press OK to confirm

**CH+ / CH-** Press to scan through channels.

**VOL+ / VOL-** Press to increase / decrease the sound level.

**INFO** Displays the source and channel information

**CC** Press to set the closed caption.

**V-CHIP** Switch to V-CHIP input.

**CH.LIST** Press to display the TV program list.

**ASPECT** Press to select Aspect Ratio.

**THUMBSTICK (▲ / ▼ / ◀ / ▶ / OK)**

Allows you to navigate the on-screen menus and adjust the system settings to your preference.

**MENU** Displays the main TV menu.

**EXIT** Exit the main TV menu.

**FAV** Press to display the favourite program list.

**ADD/ERASE** Add/Erase channel to favourite program list.

**FAV+ FAV-**

Press these two keys to switch to your favourite programs.

## REMOTE CONTROL

---

### Remote control setup

1. Open the cover.
2. Uses AAA size batteries. When inserting the batteries, make sure correct polarities "+" and "-" marks on the batteries line up correctly with compartment markings.
3. Replace the battery cover.

**To prevent battery leakage which may result in bodily injury or damage to the remote:**

1. Install all batteries correctly, and as marked on the remote control.
2. Do not mix batteries:(OLD and NEW or CARBON and ALKALINE, etc)  
Remove batteries when the remote is not used for a long period of time.



## 9.Menu Operation

### SETUP WIZARD

#### Select Language

English

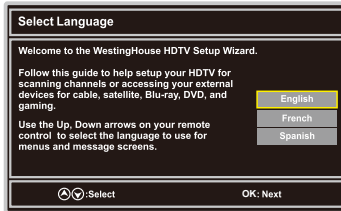

#### Power On Mode

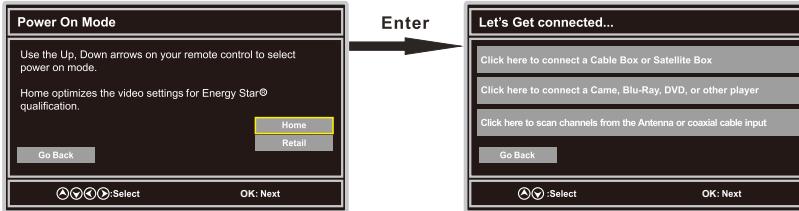

# MENU OPERATION

English

## Channel Scan

Let's Get connected...

Click here to connect a Cable Box or Satellite Box

Click here to connect a Camc, Blu-Ray, DVD, or other player

Click here to scan channels from the Antenna or coaxial cable input

Go Back

Select OK: Next

Antenna

Cable/  
Satellite

Scan Channels from the Antenna or coaxial cable input

Use the Up, Down arrows on your remote control to select the channel scan type.

Antenna(ATSC)  
Cable

Go Back

Select OK: Next

Cable or Satellite Source Input

Use the Left, Right arrows on your remote control to select the input connected to the set top box?  
For optimal video quality, we recommend HDMI or YPbPr (refer to Quick Connect Guide or User Manual to help you determine what connection you are using).

HDMI1 HDMI2 HDMI3 YPbPr/AV

Antenna

Go Back

Select OK: Next

Scanning Channel Program

Analog	:	0
Digital	:	0
RF CH	:	5
Total Found	:	0

Menu:Skip dtv

Antenna RF Warning

Notice: Westinghouse Digital does not recommend using the RF Antenna input as your cable or satellite connection because it will provide poor video quality to your HDTV. Use a different connection for optimum conditions. If you do not have a cable box that provides an HD quality signal, we recommend that you call your cable provider for an upgrade. Otherwise, select Proceed.

Exit Setup Proceed

Go Back

Select OK: Next

Source Input List

AV
YPbPr
HDMI1
HDMI2
HDMI3
VGA
USB

Go Back

Select OK: Next

## Select Input Source



- Press **SOURCE** button to display the input source list.
- Press **▼/▲** button to select the input source you want to watch.
- Press **ENTER** button to enter the selected source.

English

## Basic Operation



- Press **MENU** button to display the MAIN OSD MENU.
- Press **◀/▶** button to select the MENU you want.
- Press **ENTER** button to enter the sub menu.
- Press **▼/▲** button to select the option and then press **◀/▶** to adjust the value in the sub menu.
- You can press **MENU** button to go back to the upper menu or **EXIT** button to close the OSD.

## For TV Mode:

### PICTURE Menu

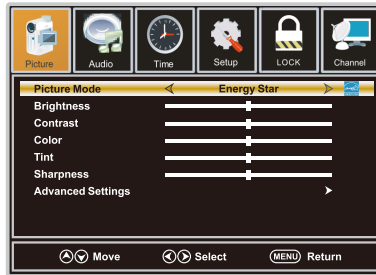

1. Press ◀/▶ button to select **Picture** in the main menu.
2. Press ▼/▲ button to select the option that you want to adjust in the Picture menu.
3. Press ◀/▶ button to desired level.
4. When you have changed the settings, you can exit from the menu by pressing MENU.

#### Picture Mode

Press ▼/▲ button to select Picture Mode, then press ◀/▶ button to adjust. Only in the User mode, the detailed options as follows can be adjusted. Available picture mode: Energy Star, Retail, Movie, User.

#### Brightness

Press ▼/▲ button to select Brightness, then press ◀/▶ button to adjust.

#### Contrast

Press ▼/▲ button to select Contrast, then press ◀/▶ button to adjust.

#### Color

Press ▼/▲ button to select Color, then press ◀/▶ button to adjust.

#### Tint

Press ▼/▲ button to select Tint, then press ◀/▶ button to adjust. (only in user mode)

#### Sharpness

Press ▼/▲ button to select Sharpness, then press ◀/▶ button to adjust.

**Advanced Settings**

Press ▼/▲ button to select Advanced Settings, then press ENTER button to enter.  
Adjust advanced video features to fine tune the picture.

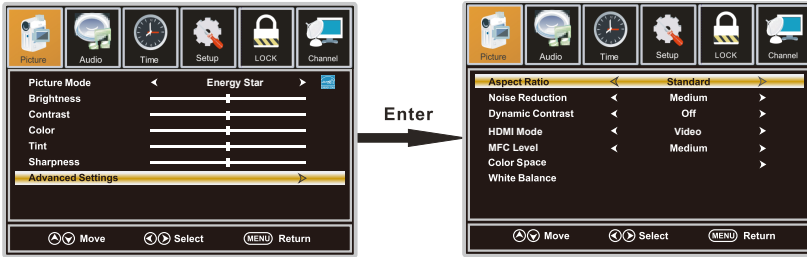

**Aspect Ratio**

Press ▼/▲ button to select Aspect Ratio, then press ◀/▶ button to adjust. Available Aspect Ratio: Standard, Fill, Over Scan.

**Noise Reduction**

Press ▼/▲ button to select the item Noise Reduction, then press ◀/▶ button to adjust.  
Available Noise Reduction: Off, Weak, Medium, Strong.

**Dynamic Contrast**

Press ▼/▲ button to select Dynamic Contrast, then press ◀/▶ button to adjust On or Off. It can adjust the contrast corresponding to the input signal in order to improve the picture quality displayed.

**Color Space**

Press ▼/▲ button to select Color Space, then press ENTER button to enter.

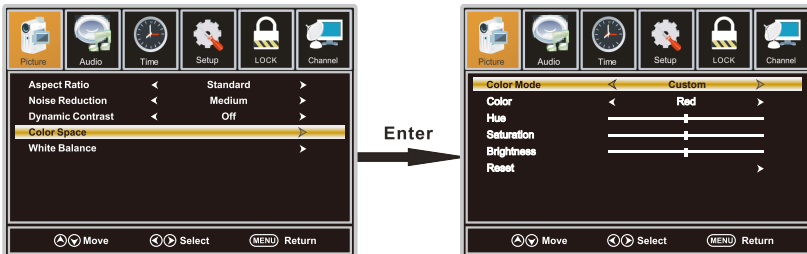



## MENU OPERATION

### Color Mode

Press ▼/▲ button to select Color Mode, then press ◀/▶ button to adjust. Available Color Mode: Auto, Native, Custom.

### Color

Press ▼/▲ button to select Color, then press ◀/▶ button to adjust. Available Color Mode: Red, Green, Blue, Yellow, Cyan, Magenta.(It is available in Custom mode.)

### Hue

Press ▼/▲ button to select Hue, then press ◀/▶ button to adjust.(It is available in Custom mode.)

### Saturation

Press ▼/▲ button to select Saturation, then press ◀/▶ button to adjust.(It is available in Custom mode.)

### Brightness

Press ▼/▲ button to select Brightness, then press ◀/▶ button to adjust.(It is available in Custom mode.)

### Reset

Press ▼/▲ button to select Reset, Press ENTER to enter, then press ◀/▶ button to select No or Yes.

### White Balance

Press ▼/▲ button to select White Balance, then press ENTER button to enter.

Press ▼/▲ button to select the option you want,then press ◀/▶ button to adjust.

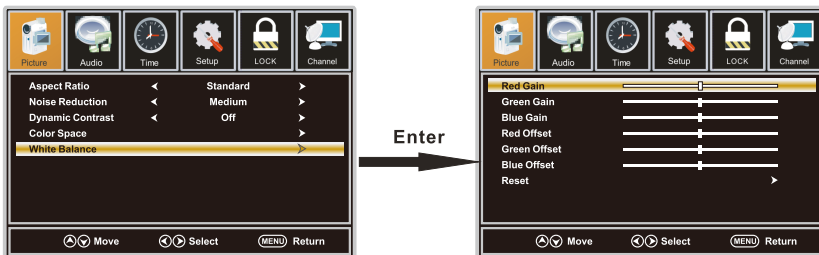

## SOUND Menu

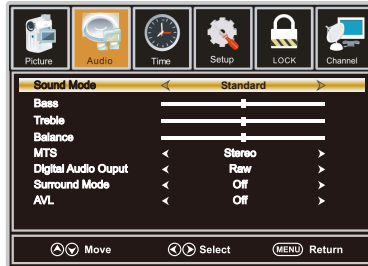

1. Press ◀/▶ button to select **Audio** in the main menu.
2. Press ▼/▲ button to select the option that you want to adjust in the Sound menu.
3. Press ◀/▶ button to desired level.
4. When you have changed the settings, you can exit from the menu by pressing MENU.

### Sound Mode

Press ▼/▲ button to select the item Sound Mode , then press ◀/▶ button to select the desired mode.  
Available Sound Mode : Sports, User, Standard, Music, Movie. Select a sound mode to achieve ideal sound.

### Bass

Press ▼/▲ button to select Bass, then press ◀/▶ button to adjust.(It is available in User mode.)

### Treble

Press ▼/▲ button to select Treble , then press ◀/▶ button to adjust.(It is available in User mode.)

### Balance

Press ▼/▲ button to select Balance, then press ◀/▶ button to adjust.(It is available in User mode.)

### MTS

Press ▼/▲ button to select MTS , then press ◀/▶ button to adjust.

### Digital Audio Output

Press ▼/▲ button to select the item Digital Audio Output, then press ◀/▶ button to select the desired digital audio output. Available digital audio output: PCM, Raw and Off .

### Surround Mode

Press ▼/▲ button to select the item Surround Mode , then press ◀/▶ button to select On or Off.

### AVL

Press ▼/▲ button to select the item AVL, then press ◀/▶ button to select ON or OFF. Auto Volume Level can set the volume automatically adjust corresponding to the input audio.

**TIME Menu**



1. Press ◀/▶ button to select **Time** in the main menu.
2. Press ▼/▲ button to select the option that you want to adjust in the Time menu.
3. Press ◀/▶ button to desired level.
4. When you have changed the settings, you can exit from the menu by pressing MENU.

**Sleep Timer**

Press ▼/▲ button to select Sleep Timer, then press ◀/▶ button to set.

Available Sleep Timer: Off, 5Min, 10Min, 15Min, 30Min, 60Min, 90Min, 120Min, 180Min, 240Min.

## SETUP Menu



English

1. Press ◀/▶ button to select **Setup** in the main menu.
2. Press ▼/▲ button to select the option that you want to adjust in the Setup menu.
3. Press ◀/▶ button to desired level.
4. When you have changed the settings, you can exit from the menu by pressing MENU.

### Menu Language

Press ▼/▲ button to select the item Menu Language, then press ◀/▶ button to adjust.  
Available Language: English, French, Spanish.

### OSD Timeout

Press ▼/▲ button to select OSD Timeout, then press ◀/▶ button to set.  
Available OSD Timeout: 5Sec., 15Sec., 30Sec., 45Sec., 60Sec..

### Closed Caption

Press ▼/▲ button to select Closed Caption, then press ENTER button to enter.

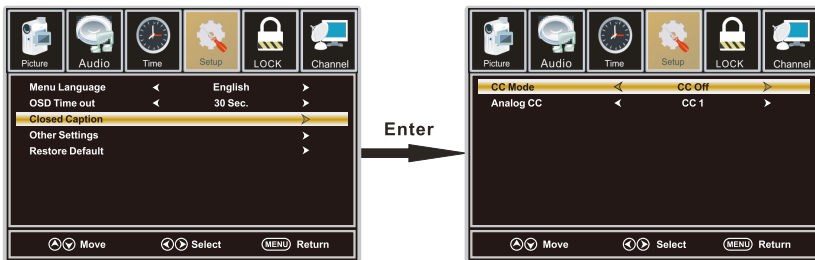

### CC Mode

Press ▼/▲ button to select CC Mode, then press ◀/▶ button to select CC Off , CC On, CC on Mute.

## MENU OPERATION

### Analog CC

Press ▼/▲ button to select Analog CC, then press ◀/▶ button to select.

Available Analog CC: CC1, CC2, CC3, CC4, Text1, Text2, Text3, Text4.

### Other Settings

Press ▼/▲ button to select Other Settings, then press ENTER button to enter.

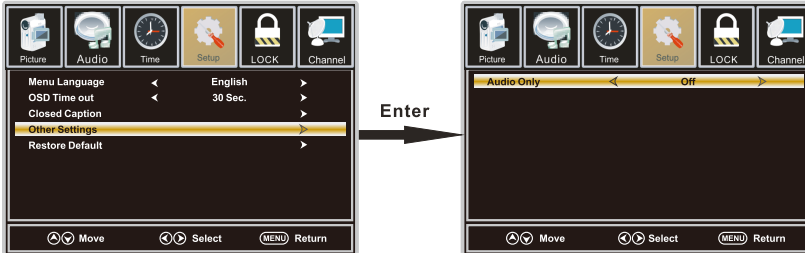

### Audio Only

Press ▼/▲ button to select Audio Only, then press ◀/▶ button to set On or Off.

### Restore Default

Press ▼/▲ button to select Restore Default, then press ENTER button to select No or Yes.

Change power on options or reset TV to factory default. (0000)

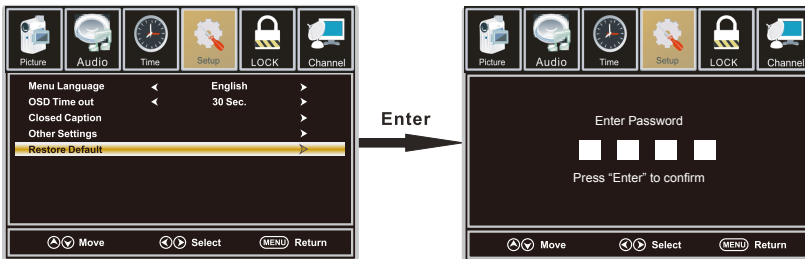

## LOCK Menu

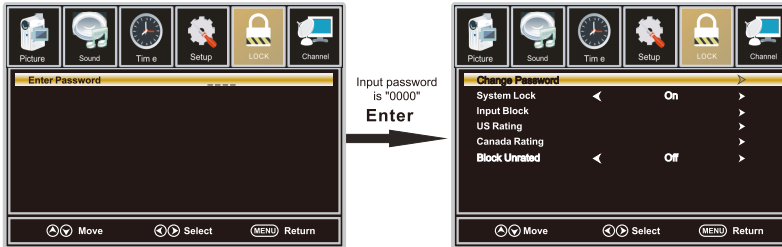

English

1. Press ◀/▶ button to select **Lock** in the main menu.
  2. Press ▼/▲ button to select the option that you want to adjust in the Lock menu.
  3. Press ◀/▶ button to desired level.
  4. When you have changed the settings, you can exit from the menu by pressing MENU.
- Input password to enter, default password is "0000".

### Change Password

Press ▼/▲ button to select Change Password, then press ENTER button to adjust the value. a sub menu will appear as below. If the password is changed, all of the passwords in the menu will be changed at the same time.

Note: If you forget your password, you can use "8899" to enter any menu locked.

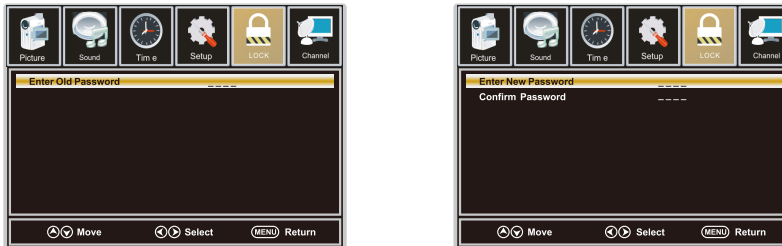

### System Lock

Press ▼/▲ button to select System Lock, then press ◀/▶ button to set On or Off. Only available when "System Lock" is "On".

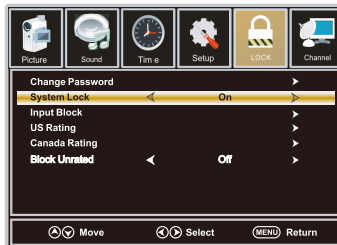

## MENU OPERATION

### Input Block

Press ▼/▲ button to select Input Block, then press ◀/▶ button to enter.

Press ◀/▶ button to select Unblock or Block the input sources.

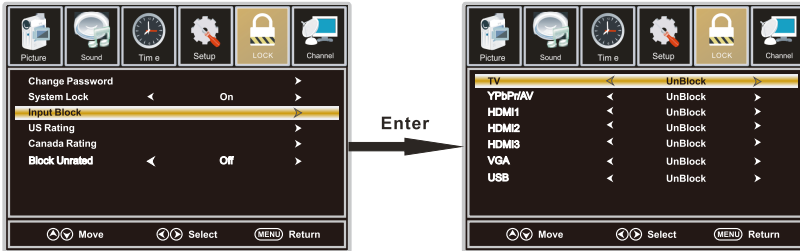

### US Rating

Press ▼/▲ button to select US Rating, then press ◀/▶ button to enter. A sub menu will appear as below.

The TV rating composes of two aspects: age-based and content-based.

This system defines the rating control which comes from MPAA rules.

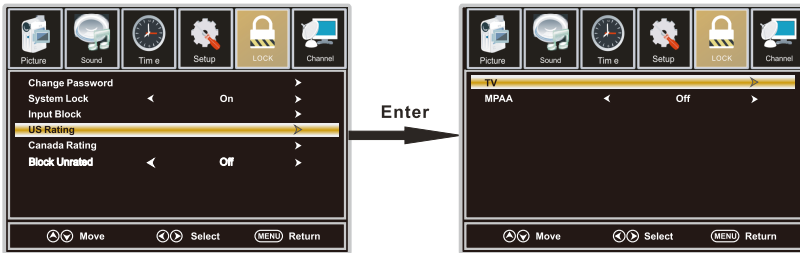

### Canada Rating

Press ▼/▲ button to select Canada Rating, then press ◀/▶ button to enter. Press ◀/▶ button to select.

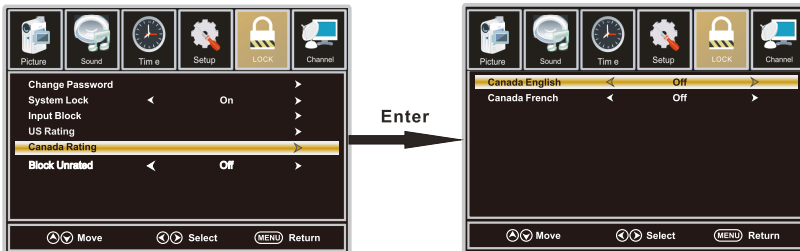

### Canada English

Press ▼/▲ button to select Canada English, then press ◀/▶ button to set.

Available Canada English: Off, C, C8+, G, PG, 14+, 18+.

### Canada French

Press ▼/▲ button to select Canada French, then press ◀/▶ button to set.

Available Canada French: Off, G, 8ans+, 13ans+, 16ans+, 18ans+.

## CHANNEL Menu

Note: This menu is only shown when the input source is TV.

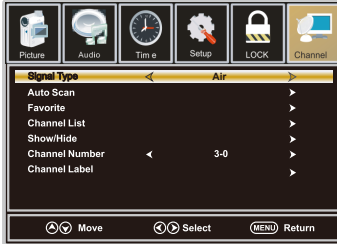

1. Press ◀/▶ button to select **Channel** in the main menu.
2. Press ▼/▲ button to select the option that you want to adjust in the Channel menu.
3. Press ◀/▶ button to desired level.
4. When you have changed the settings, you can exit from the menu by pressing MENU.

### Signal Type

Press ▼/▲ button to select Signal Type, then press ◀/▶ button to set. Available Signal Type: Air, Cable.

### Auto Scan

Press ▼/▲ button to select Auto Scan, then press ENTER button to search channel. A Channel Search Menu will appear as below.

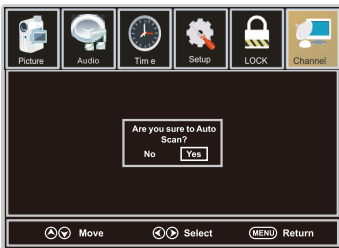

### Favorite

Press ▼/▲ button to select Favorite, then press ENTER button to scan the Favorite channel list.

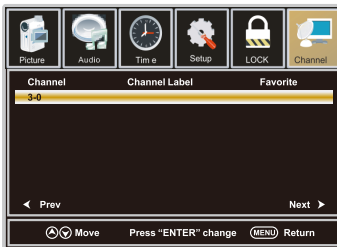



## MENU OPERATION

---

### Channel List

Press ▼/▲ button to select Channel List, then press ENTER button to scan the Channel List. If you select the option "In Channel List" On, the channel label will display in the list.

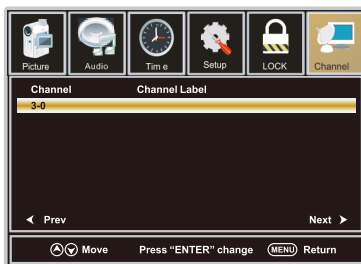

### Show/Hide

Press ▼/▲ button to select Show, then press ENTER button to enter .  
Show or hide the channels in your program list.

### Channel Number

Press ▼/▲ button to select Channel Number, then press ◀/▶ button to adjust.

### Channel Label

Press ▼/▲ button to select Channel Label, then press ENTER button to enter.  
Create labels for channels, up to 7 characters.



**SETUP Menu**

**For VGA Mode :**

1. Press ◀/▶ button to select **Setup** in the main menu.
2. Press ▼/▲ button to select VGA Settings, then press ENTER button to enter.  
A sub menu will appear as below.

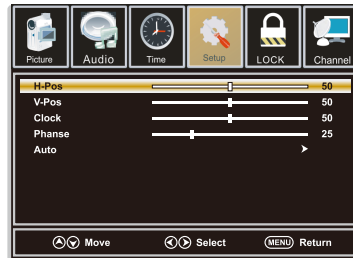

**H-Pos**

Press ▼/▲ button to select H-Pos, then press ◀/▶ button to adjust.

**V-Pos**

Press ▼/▲ button to select V-Pos, then press ◀/▶ button to adjust.

**Clock**

Press ▼/▲ button to select Clock, then press ◀/▶ button to adjust.

**Phase**

Press ▼/▲ button to select Phase, then press ◀/▶ button to adjust.

**Auto**

Press ▼/▲ button to select Auto, then press ENTER button to enter.  
Adjust to the PC signal timing automatically.

1. PICTURE menu and description are the same as that for TV mode.
2. Audio Language in SOUND menu is invalid.
3. TIME menu and description are the same as that for TV mode.
4. Close Caption in SETUP menu is invalid.
5. US, Canada, RRT Setting and Reset RRT in LOCK menu is invalid
6. PC mode has no CHANNEL menu.

Note: The operation and description of the hot key are programmable on your remote control.

## MENU OPERATION

---

### USB Menu

Note: Before operating Media menu, Plug in USB device, then press SOURCE button to set the Input Source to USB.

Press ▲/▼ button to select USB in the Source menu, then press ENTER button to enter.

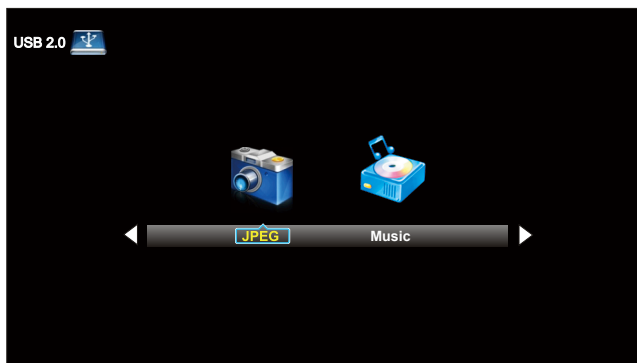

Press ◀/▶ button to select the option you want to adjust in the main Media menu, then press ENTER button to enter.

### JPEG Menu

Press ◀/▶ button to select JPEG in the main menu, then press ENTER button to enter.

Press Exit button to return back to the previous menu.

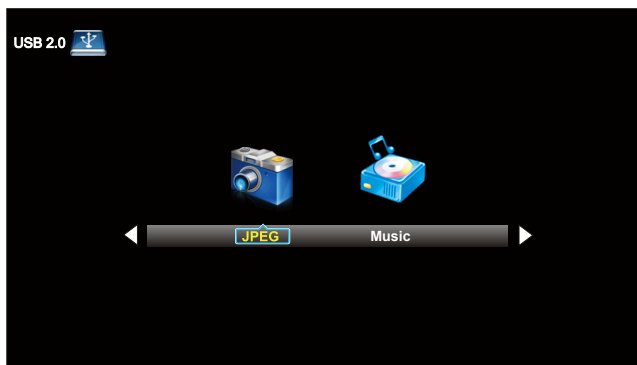

Press ◀/▶ button to select drive disk you want to watch, then press ENTER button to enter.

Press ◀/▶ button to select Return option to go back to the previous menu.

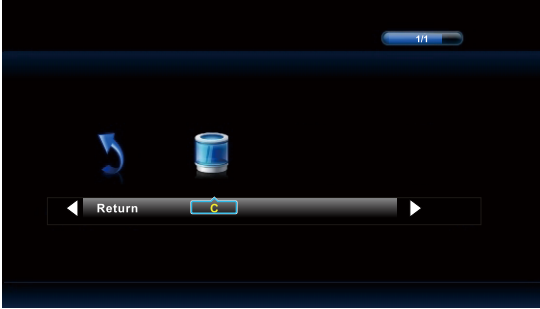

Press ◀ / ▶ button to select the file you want to watch in the file selecting menu, then press ENTER button to display picture.  
 When highlighting the option you select, the file information will appear on the right and Picture will be previewed in the center.  
 Press ◀ / ▶ button to select the file you want to delete in the file selecting menu, then press red button on your remote control and press ◀ button to delete the picture.

### M-JPEG Menu

Press ◀ / ▶ button to select M-JPEG in the main menu, then press ENTER button to enter.  
 Press EXIT button to return back to the previous menu.



Press ◀ / ▶ button to select drive disk you want to watch, then press ENTER button to enter.  
 Press ◀ / ▶ button to select Return option to go back to the previous menu.  
 When highlighting the option you select, the file information will appear on the right and Movie will be previewed in the center.  
 Press ENTER button to play the selected movie.  
 Press display button to show select menu in the bottom.  
 Press ◀ / ▶ button to select menu in the bottom you want to run, then press ENTER button to operate.

## 10. Troubleshooting

Please check if you can solve problems by troubleshooting yourself.

Troubleshooting	Control
No signal	Please check that all cables are correctly plugged in.
No color shades	Adjust the contrast, the color and the brightness.
Stain on the screen	May be the result from a lighting signal from car, motor, neon light and other electrical devices or appliances.
Double or multiple display image	May be the result of an electrical wave disturb from other TV, Computer and Game machine or Radio.
Snow on the screen	The cables of the antenna are not correctly plugged in.
The remote control does not work	Please check the batteries order and alignment. Check that the IR of the remote control is not hidden by something.
"Zip" made noise on TV cover	Even if the display image is correct, the noise may come from an unsteady fixation of the panel.
No sound	Make sure that you have not press the MUTE button of the remote control.

## 11. SPECIFICATIONS

This manual is only for your reference, any change to the design and specification will not be advised.

Screen Size		46 Inch
Display Type		TFT LED
Resolution(Pixel)		1920 X 1080
Aspect Ratio		16:9
Power Supply		AC100-240V 50/60Hz
Power Consumption		120W
TV System		ATSC/NTSC
Video Input Format		PAL/NTSC
Audio Output Power		L / R 2X8W
SUPPORT	ANTENNA	YES
	AV-IN	YES
	YPbPr - IN	YES
	HDMI - IN	YES
	VGA(PC) - IN	--
	VGA(PC) AUDIO - IN	--
	SCART - IN	--
	SCART - OUT	--
	HEADPHONE - OUT	--
	S-VIDEO - IN	--
	COAXIAL - OUT	YES
	COMMON INTERFACE	--
	USB	JPEG, M-JPEG
	IPOD	--
DVD	Disc Physical Format	--
	DVDVideoOutputFormat	--
Dimensions	Inc Stand (LxWxHmm)	1060x255x693 mm
	Exc Sand (LxWxHmm)	1060x93 x626mm
Weight	Net (Kgs)	15.8
	Gross (Kgs)	18.6



[www.westinghousedigital.com](http://www.westinghousedigital.com)



S/N: \_\_\_\_\_



Westinghouse Digital, LLC  
Orange, CA

SE-UM-4602-1301